



WD series DIN Rail or Screw Mounted Protective Relays

- WD25 Paralleling (Synch Check) Relays
- WD2759 Over/undervoltage Relays
- WD32 Reverse Power Relays
- WD47 Phase Sequence Relays
- WD5051 Single- or Three-Phase Overcurrent Relays
- WD810U Over/Underfrequency Relays

File E58048

DIN EN50022-35

Users should thoroughly review the technical data before selecting a product part number. It is recommended that user also seek out the pertinent approvals files of the agencies/laboratories and review them to ensure the product meets the requirements for a given application.

Overview

The WD series offers several different models of protective relays in a common package that is suitable for either DIN rail or screw mounting. These flexible, multifunction devices offer user selectable voltages, sense currents and frequencies. Adjustable time delays are standard. This allows a single part number to be suitable for multiple applications, thereby reducing inventory costs.

Specifications common to all models

- Power Consumption:** 2.5VA, maximum.
- Contact Ratings:** 5 amps, resistive, at 120VAC.
5 amps, resistive, at 30VDC.
- Isolation from Control to Sense Inputs:** 2,500VAC.
- Mechanical Life:** 10 million operations.
- Shock:** 10g.
- Vibration:** 0.062 (1.57) double amplitude at 10-55 Hz.
- Terminals:** M3.5 screws.
- Maximum Wire Size:** 2 x 24 AWG (2.5mm²) solid to DIN 46288 or 2 x 16 AWG (1.5mm²) stranded w/end sleeves.
- Operating Temperature Range:** -40°C to +60°C.
- Storage Temperature Range:** -55°C to +85°C.
- Operating Humidity (Max.):** 90%, non-condensing.
- Enclosure:** Plastic case (not sealed).
- Mounting Options:** Snap mounts on standard DIN rail (DIN-EN 50022-35) or panel mounts with M4, M5, #8 or #10 screws.
- Weight:** 14.4 oz. (400g) approximately.

Installation and Maintenance Information

Installation: To mount the WD series protective relay on a DIN rail, hook the top edge of the cutout on the base of the case over one edge of the DIN rail, then press the opposite side of the cutout containing the release clip over the opposite side of the DIN rail. To remove or reposition the relay, lever the release clip and move the relay as required. WD series relays should be installed in a dry location where the ambient temperature will be within the operating temperature range.

Maintenance: WD series protective relays are solid state devices that require no maintenance. They are not designed to be serviced by the user. Consult KILOVAC customer service at 805-220-2023 if repairs should be necessary.

Outline Dimensions

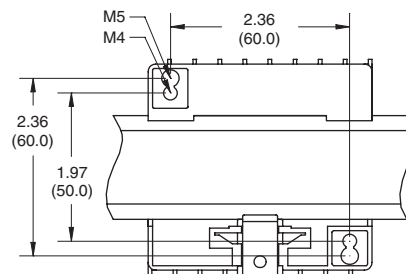
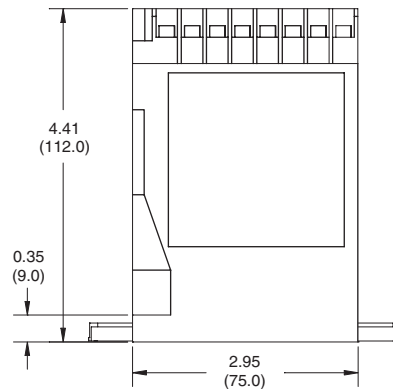
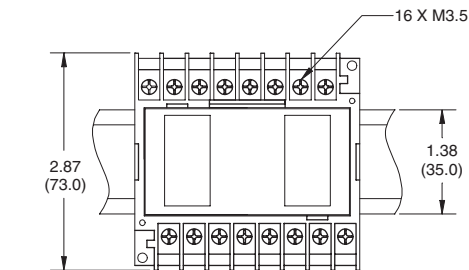

WD25 Paralleling Relays

- Function 25
- ANSI/IEEE C37.90-1978

WD25 Operation

WD25 paralleling relays are used to ensure that two circuits are synchronized. When voltage, phase relationship and frequency are within the selected synchronizing limits, the output relay will energize. The WD25 paralleling relay allows for a generator to be brought online without damage or system disturbance. WD25 series with a "dead bus" feature will energize for a synchronized condition or an "on line" generator, "dead bus" condition. This "dead bus" feature allows the generator to energize a dead bus. The "double dead bus" feature permits paralleling of two buses when: (a) both the line voltages are equal and in phase, or (b) when either bus is "hot" and the other bus is "dead."

WD25 Specifications

Nominal Operating Range: 120, 208, 277 or 480 VAC, selectable.

Maximum Sensing Range: 575VAC.

Nominal Frequency Range: 40-400.

Contact Form: 2 form C (DPDT).

Sense Voltage:

Voltage (nominal)	120	208	277	480
Synch Voltage (% of nom.)	6 - 30% (≈ 4° - 20° electrical degree)			
Dead Bus Voltage (% of nom.)	10 - 70% (Dead Bus)			

Control Voltage:

Model WD25	-0X1	-0X2	-0X3
Input Voltage (VDC)	18 to 54	13.5 to 32	100 to 200
Input Voltage (VAC)	-	-	100 to 140

Ordering Information

Typical Part Number ▶

WD 25 -00 2

1. Basic Series:

WD = DIN mount Protective Relay.

2. Type:

25 = Paralleling Relay.

3. Dead Bus:

00 = Double Dead Bus

01 = Single Dead Bus

02 = Generator to Generator

4. Control Voltage:

1 = 18 to 54VDC

2 = 13.5 to 32 VDC

3 = 100-200VDC or 100-140VAC.

Our authorized distributor is more likely to stock these items.

WD25-001

WD25-013

WD25 Typical Hookup

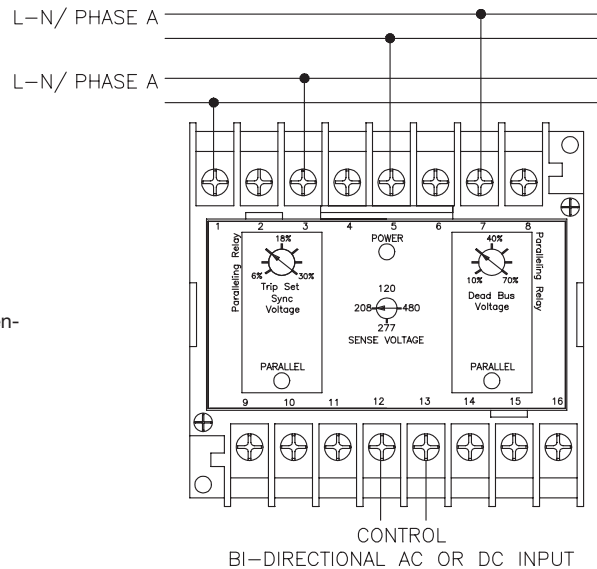

NOTE:

For single dead bus option, connect the generator to 1 & 2 and the bus to 4 & 5.

WD25 Calibration

The calibration marks on the faceplate are provided only as guides. Proper calibration requires using an accurate voltmeter. Use the following procedure to calibrate the WD25:

1. Remove the cover.
2. Adjust the SYNC VOLTAGE control fully counterclockwise (CCW). Apply nominal voltage to the LINE B (bus) sensing terminals.
3. Apply the maximum desired synchronization voltage to the LINE A (generator) terminals. This voltage should be in phase with LINE B (bus) voltage and have the same frequency.
4. Slowly adjust the SYNC VOLTAGE control clockwise (CW) until the relay energizes.

WD25 Controls

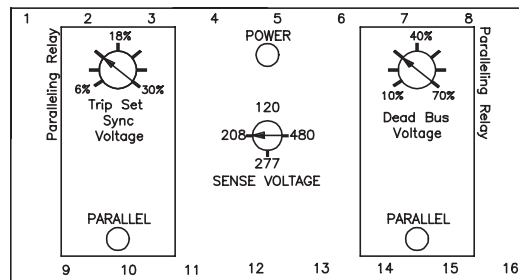

WD25 Connections

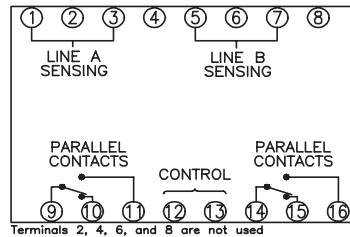

WD2759 Over/Undervoltage Relays

- Function 27/59
- ANSI/IEEE C37.90-1978

WD2759 Operation

WD2759 AC voltage sensing relays provide voltage monitoring and protection in AC systems from 50 to 400 Hz. Sensing voltages, number of phases, over and undervoltage setpoint, and time delays are user configured. WD2759 voltage relays operate when the externally adjustable trip point is reached. An external time delay control is provided with an adjustment of .5 to 10 seconds. This time delay may be used to prevent false tripping when there are slight variations in the voltage supply. On overvoltage (OV) the output relay energizes when the input signal exceeds the trip point. On undervoltage (UV) the output relay energizes when the input signal goes below the trip point. A green LED indicates power to the relay. Red LED lights indicate the state of the undervoltage and overvoltage trips.

WD2759 Specifications

Nominal Operating Range: 120, 208, 277 or 480 VAC, selectable.

Maximum Sensing Range: 700VAC.

Nominal Frequency Range: 50-400 Hz.

Contact Form: 1 form C (SPDT) for undervoltage and 1 form C (SPDT) for overvoltage.

Time Delay Adjustment: 0.5 to 10 sec.

Sense Voltage:

Voltage (nominal)	120	208	277	480
UV Adjustment Range	72-120	125-208	166-277	288-480
OV Adjustment Range	120-168	208-291	277-388	480-672

Control Voltage:

Model WD2759	-001	-002	-003
Input Voltage (VDC)	18 to 54	13.5 to 32	100 to 200
Input Voltage (VAC)	-	-	100 to 140

Ordering Information

Typical Part Number ►

WD 2759 -002

- Basic Series:**
WD = DIN mount Protective Relay.
- Type:**
2759 = Over/Undervoltage Relay.
- Control Voltage:**
001 = 18 to 54VDC
002 = 13.5 to 32 VDC
003 = 100-200VDC or 100-140VAC.

Our authorized distributor is more likely to stock these items.

WD2759-003.

WD2759 Typical Hookup

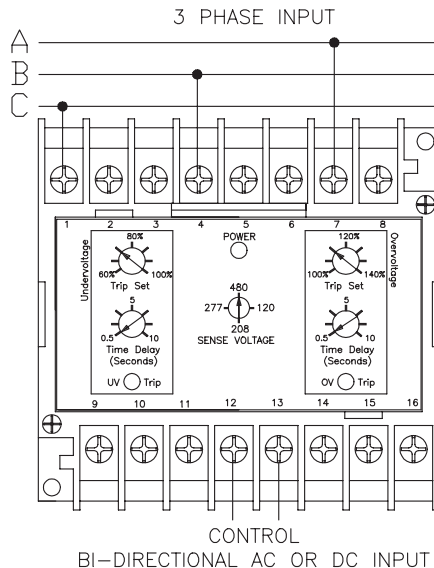
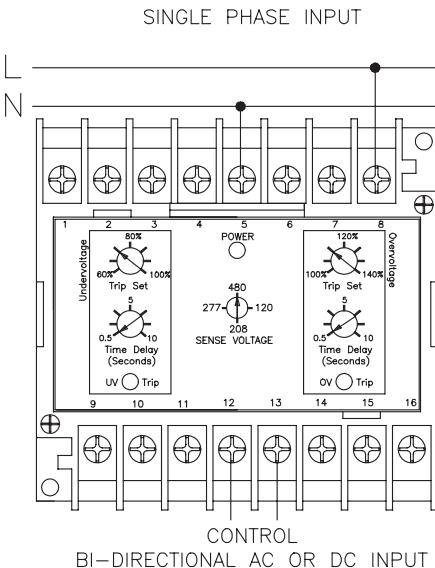

WD2759 Calibration

The calibration marks on the faceplate have a maximum error of 10% and are provided only as guides. Proper calibration requires using an accurate voltmeter in parallel with the input signal. Use the following procedure to calibrate your relay.

OVER VOLTAGE

1. Remove cover.
2. Adjust the TRIP SET control fully clockwise (CW) and the TIME DELAY control fully counterclockwise (CCW).
3. Apply the desired trip voltage to the relay.
4. Slowly adjust the TRIP SET control CCW until the relay trips.
5. Remove the applied voltage (do not change the voltage level) and set the TIME DELAY control to the desired time delay.
6. Apply the trip voltage to the relay and measure the time to trip.
7. Adjust the TIME DELAY and repeat steps 4 and 5 until you have the desired time delay.

UNDER VOLTAGE

1. Remove cover.
2. Adjust the TRIP SET control fully CCW and the TIME DELAY control fully CCW.
3. Decrease the applied sensing voltage from the nominal value until the desired tripping voltage is reached.
4. Slowly adjust the TRIP SET control CW until the relay trips.
5. Set the TIME DELAY control to the desired time delay and apply nominal voltage to the relay.
6. Step down the applied voltage from nominal to a level just below the trip level set in Step 3 and measure the time delay.
7. Adjust the TIME DELAY and repeat steps 4 and 5 until the desired time delay is achieved.

WD2759 Controls

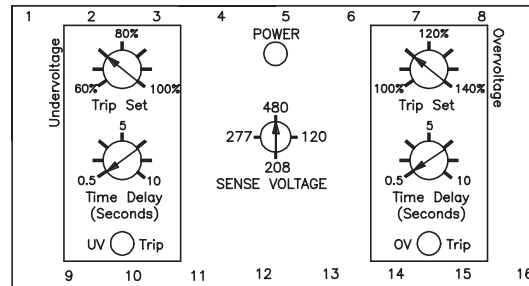

WD2759 Connections

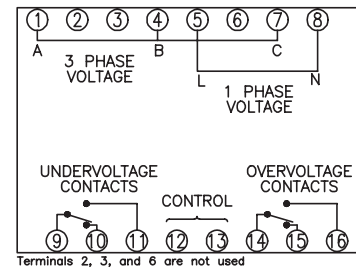

WD32 Reverse Power Relays

- Function 32

WD32 Operation

WD32 reverse power relays are used to monitor the direction of power from AC generators. This is accomplished by measuring $I \cos \phi$. If current from the generator is reversed and exceeds the adjustable setting, the relay will trip. A 0.5 to 20 second time delay is provided. A correct setting of the trip point and time delay will prevent motorizing the generator and prevent tripping during transients that occur while synchronizing. A POWER LED indicates the condition of the power supply and a REVERSE POWER TRIP LED indicates the output status of the relay.

WD32 Specifications

Nominal Operating Range: 120 to 480 VAC, 1 or 3 phase.
Maximum Sensing Range: 575VAC.
Nominal Sensing Current: 5A.
Nominal Frequency Range: WD32-00X: 40-400 Hz.; WD32-01X: 60 Hz.
Contact Form: 2 form C (DPDT).
Time Delay Adjustment: 0.5 to 20 sec.
Sense Current:
 Reverse Power Trip: 0.2 to 1.0A (4-20% of nominal sense current).

Control Voltage:

Model WD32	-001	-002	-003
Input Voltage (VDC)	18 to 54	13.5 to 32	100 to 200
Input Voltage (VAC)	-	-	100 to 140

Ordering Information

Typical Part Number ▶

WD 32 -00 2

1. Basic Series:

WD = DIN mount Protective Relay.

2. Type:

32 = Reverse Power Relay.

3. Load:

00 = Resistive (power)
 01 = Inductive (Kvar, 60 Hz.)

4. Control Voltage:

1 = 18 to 54VDC
 2 = 13.5 to 32 VDC
 3 = 100-200VDC or 100-140VAC.

Our authorized distributor is more likely to stock these items.

WD32-003
 WD32-011

WD32 Calibration

The calibration marks on the faceplate have a maximum error of 10% and are provided only as guides. Proper calibration requires using an accurate Current Meter in series with the input current. Use the following procedure to calibrate your relay.

REVERSE POWER

1. Remove cover.
2. Adjust the TRIP SET control fully clockwise (CW) and the TIME DELAY control fully counterclockwise (CCW).
3. Apply the desired trip current to the relay. NOTE: for the Reverse Power (WD32-00X) a resistive load must be used and for the Reverse KVAR (WD32-01X) an inductive load must be used.
4. Slowly adjust the TRIP SET control CCW until the relay trips.
5. Remove the applied Current and set the TIME DELAY control to the desired time delay.
6. Re-apply the Current (10% more than the trip current) to the relay and measure the time to trip.
7. Adjust the TIME DELAY and repeat steps 4 and 5 until you have the desired time delay.

WD32 Controls

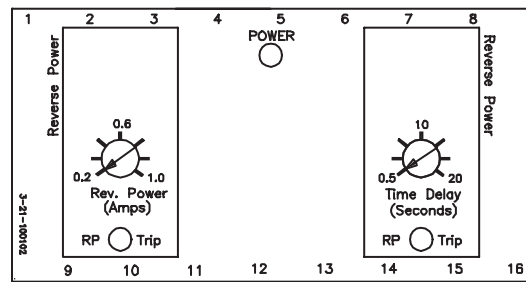

WD32 Connections

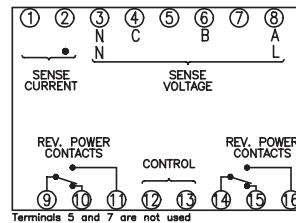

WD32 Typical Hookup

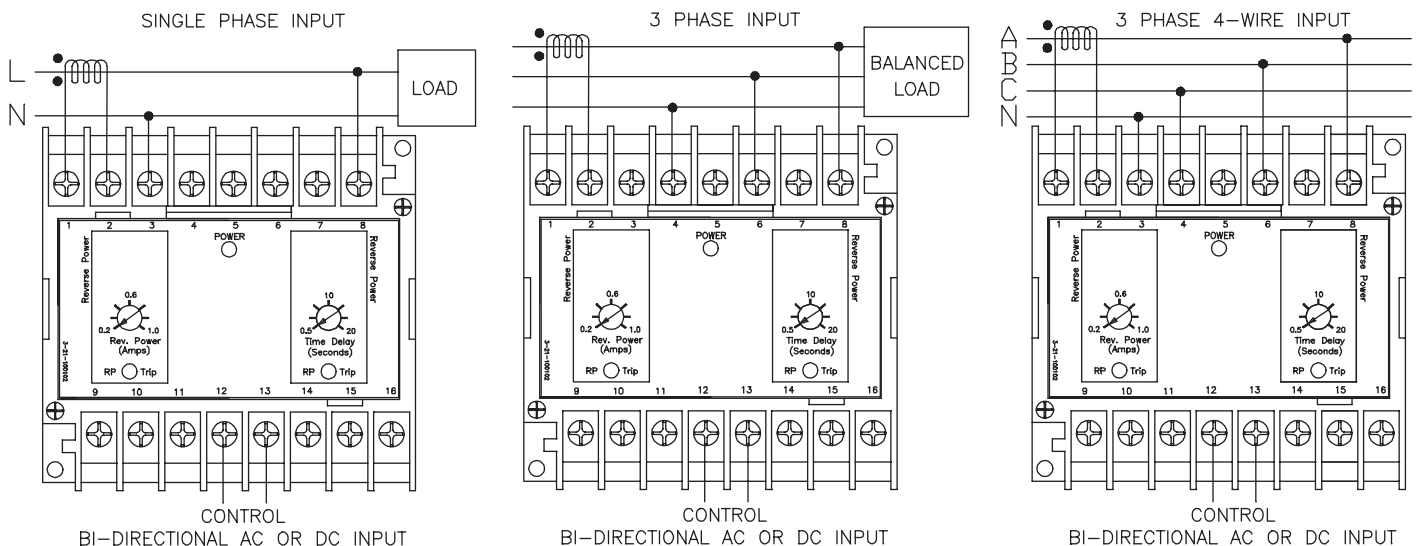

Dimensions are shown for reference purposes only.

Dimensions are in inches over (millimeters) unless otherwise specified.

Specifications and availability subject to change.

www.tycoelectronics.com
 Technical support:
 Refer to inside back cover.

WD47 Phase Sequence Relays

- Function 47
- ANSI/IEEE C37.90-1978

WD47 Operation

WD47 phase sequence relays are designed to monitor the correct phase rotation and loss of phase of three phase ac systems from 50 to 400 Hz. An incorrect phase sequence or loss of any phase will cause the WD47 to pickup. When the phase sequence is corrected or the lost phase is restored the contacts dropout. Red LED's light to indicate a fault condition. A green LED indicates power to the relay. The WD47 is often used to detect reverse phase rotation or loss of phase to generators, busses, motors, and transformers.

WD47 Specifications

Nominal Operating Range: 120 to 480 VAC.

Maximum Sensing Range: 575VAC.

Nominal Frequency Range: 40-400 Hz.

Contact Form: 2 form C (DPDT).

Control Voltage:

Model WD47	-001	-002	-003
Input Voltage (VDC)	18 to 54	13.5 to 32	100 to 200
Input Voltage (VAC)	-	-	100 to 140

Ordering Information

Typical Part Number ▶

WD 47 -002

1. Basic Series:

WD = DIN mount Protective Relay.

2. Type:

47 = Phase Sequence Relay.

3. Control Voltage:

001 = 18 to 54VDC

002 = 13.5 to 32 VDC

003 = 100-200VDC or 100-140VAC.

Our authorized distributor is more likely to stock these items.

WD47-001

WD47 Controls

The WD47 has no adjustments and no calibration is necessary. Proper operation may be verified as follows:

1. Apply a nominal, three-phase input with the correct phase sequence. The output relay should dropout and the green LED should light.
2. Apply a nominal, three-phase input with an incorrect phase sequence. The output relay should pickup and the red LED should light.
3. Apply only one or two phases with the correct phase sequence. The output relay should pickup and the red LED should light.

WD47 Connections

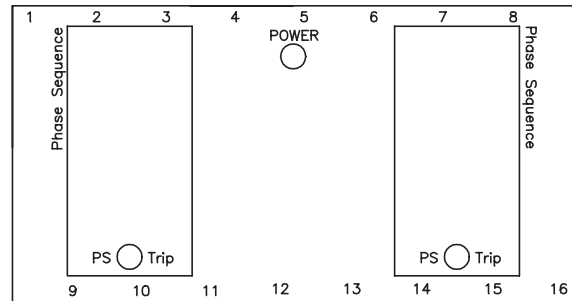

WD47 Connections

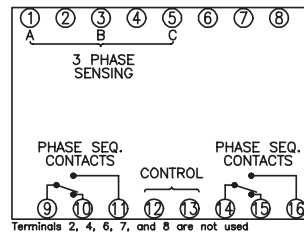

WD47 Typical Hookup

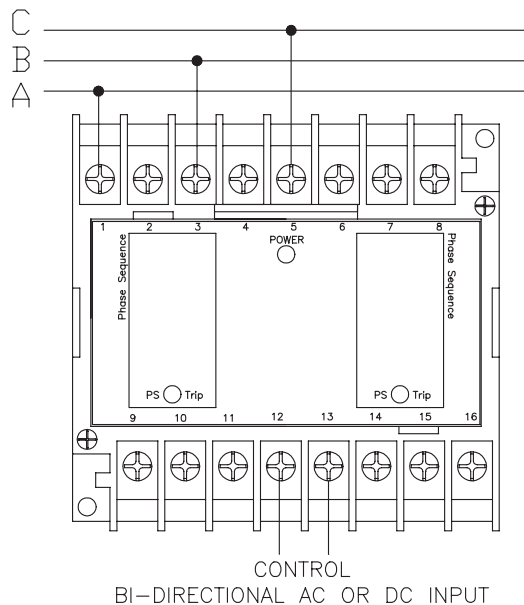

WD5051 1Ø and 3Ø Overcurrent Relays

- Function 5051

WD5051 Operation

WD5051 AC current sensing relays provide current monitoring and protection in AC systems from 50 to 400 Hz. Nominal Sensing Current, Instantaneous Over Current setpoint, Time Over Current setpoint, and Time Over Current time delay are user configured. WD5051 current relays operate when the externally adjustable trip point is reached. An external time over current time delay control is provided with an adjustment of .5 to 20 seconds. This time delay may be used to prevent false tripping when there are slight variations in the sensed current. With control power applied, the Instantaneous Over Current (IOC) contacts pick-up when the input signal exceeds the IOC trip setpoint. Similarly, with control power applied, the Time Over Current (TOC) contacts pick-up after the preset time delay when the Sense Current rises above the TOC trip setpoint. The IOC contacts may also be configured to function as an under current relay. A green LED indicates power to the relay. Red LED lights indicate the state of the IOC and TOC trips.

WD5051 Specifications

Sense Current Full Scale: 1, 3, 6 or 8A, selectable.

Maximum Sensing Current: 10A continuous; 30A for 10 sec.;
60A for 2.5 sec.; 100A for 0.9 sec..

Nominal Frequency Range: 50-400 Hz.

Contact Form: 1 form C (SPDT) for IOC and 1 form C (SPDT) for TOC.

TOC Time Delay Adjustment: 0.5 to 20 sec.

IOC Operate Time (max.): 0.2 sec.

Sense Current:

Current (nominal)	1	3	6	8
IOC	0.2 to 1.2	0.6 to 3.6	1.2 to 7.2	1.6 to 9.6
TOC	0.2 to 1.2	0.6 to 3.6	1.2 to 7.2	1.6 to 9.6

Control Voltage:

Model WD5051	-001	-002	-003
Input Voltage (VDC)	18 to 54	13.5 to 32	100 to 200
Input Voltage (VAC)	-	-	100 to 140

Ordering Information

Typical Part Number ►

WD 5051 -002

1. Basic Series:

WD = DIN mount Protective Relay.

2. Type:

5051 = Single Phase Overcurrent Relay.
5051-3 = Three Phase Overcurrent Relay.

3. Control Voltage:

001 = 18 to 54VDC
002 = 13.5 to 32 VDC
003 = 100-200VDC or 100-140VAC.

Our authorized distributors are more likely to stock these items.

WD5051-001 WD5051-003 WD5051-3-001

WD5051 Typical Hookup

WD5051 Single Phase Model

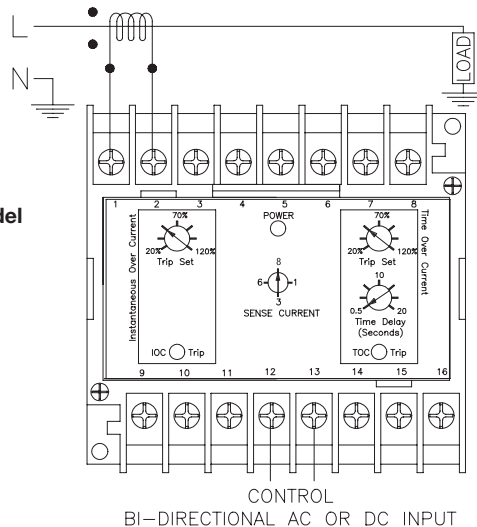

WD5051 Calibration

The calibration marks on the faceplate are provided only as guides. Proper calibration requires using an accurate ammeter in series with the current source. Use the following procedure to calibrate your relay:

1. Remove the cover.
2. Adjust the TRIP SET control fully clockwise (CW) and the TIME DELAY control (TOC only) fully counterclockwise (CCW).
3. Apply the desired trip current to the relay.
4. Slowly adjust the TRIP SET control CCW until the relay trips.
5. Remove the applied current (do not change the current level). Set the TIME DELAY (TOC only) control to the desired time delay.

WD5051 Controls

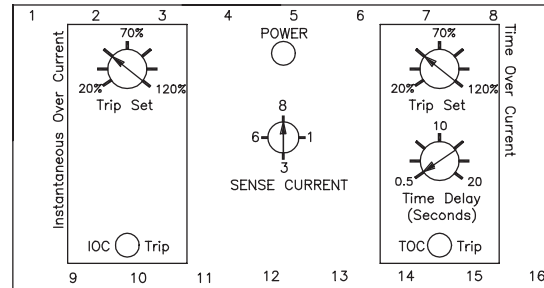

WD5051 Connections

WD5051 Single Phase Model

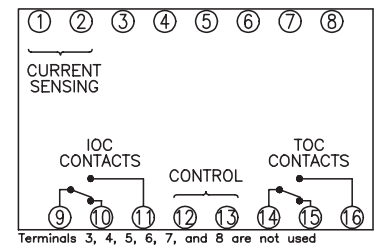

WD5051-3 Three Phase Model

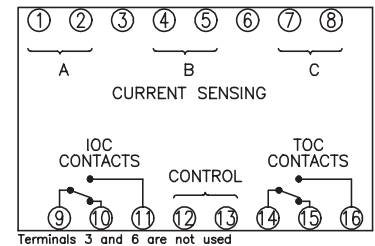

WD5051-3 Three Phase Model

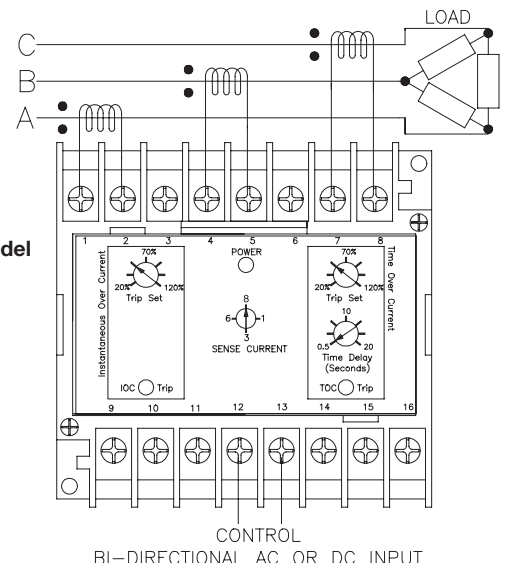

WD810U Over/Underfrequency Relays

- Function 81 OU
- ANSI/IEEE C37.90-1978

WD810U Operation

WD810U frequency relays are used to provide frequency monitoring and protection to generators, buses, power supplies, and other equipment. The relay operates at voltages from 120 to 480 Vac and at nominal frequencies of 50, 60, and 400 Hz. External controls include nominal frequency selection, under frequency (UF) trip set, over frequency (OF) trip set, UF time delay, and OF time delay. A green LED indicates power to the relay. Red LED's indicate the status of the UF and OF trips.

WD810U Specifications

Nominal Operating Frequency: 50, 60 or 400 Hz., selectable.

Maximum Frequency @ 400Hz. Nominal: 1000 Hz.

Nominal Sensing Voltage: 20-480VAC.

Maximum Sensing Voltage: 575VAC.

Contact Form: 1 form C (SPDT) for underfrequency and 1 form C (SPDT) for overfrequency.

Time Delay Adjustment: 0.5 to 10 sec.

Sense Frequency:

Frequency (nominal)	50	60	400
UF Adjustment Range	40-50	48-60	360-400
OF Adjustment Range	50-60	60-72	400-480

Control Voltage:

Model WD810U	-001	-002	-003
Input Voltage (VDC)	18 to 54	13.5 to 32	100 to 200
Input Voltage (VAC)	-	-	100 to 140

Ordering Information

Typical Part Number ►

WD 810U -002

1. Basic Series:

WD = DIN mount Protective Relay.

2. Type:

810U = Over/Underfrequency Relay.

3. Control Voltage:

001 = 18 to 54VDC

002 = 13.5 to 32 VDC

003 = 100-200VDC or 100-140VAC.

Our authorized distributors are more likely to stock these items.

None at present.

WD810U Typical Hookup

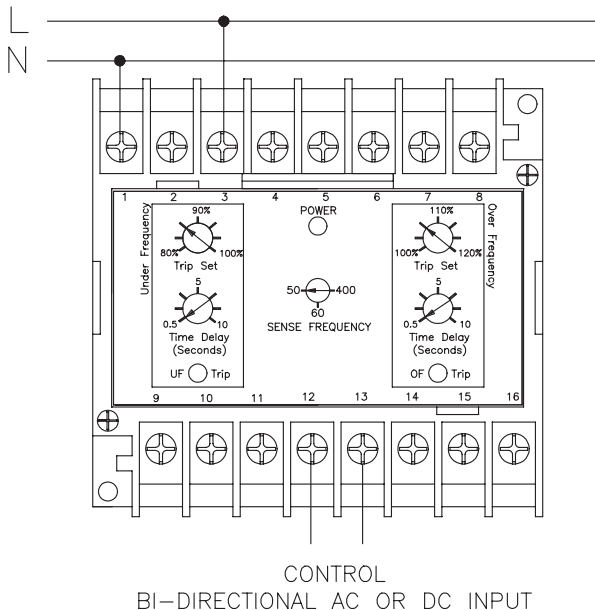

WD810U Calibration

The calibration marks on the faceplate are provided only as guides. Proper calibration requires using an accurate frequency meter in parallel with the input signal.

UNDER FREQUENCY

1. Remove the cover.
2. Set the SENSE FREQUENCY to the nominal system frequency. Adjust the Under Frequency TRIP SET fully clockwise (CW) and the TIME DELAY control fully counterclockwise (CCW).
3. Apply the desired trip frequency to the relay.
4. Slowly adjust the TRIP SET control CCW until the relay trips.
5. Set the TIME DELAY control to the desired time delay and apply nominal frequency to the relay.
6. Step down the applied frequency from nominal to just below the trip level set in Step 4 and measure the time delay.
7. Adjust the TIME DELAY and repeat steps 5 and 6 until the desired time delay is set.

OVER FREQUENCY

1. Remove the cover.
2. Set the SENSE FREQUENCY to the nominal system frequency. Adjust the OF TRIP SET and TIME DELAY controls fully counterclockwise (CCW).
3. Apply the desired trip frequency to the relay.
4. Slowly adjust the TRIP SET control clockwise (CW) until the relay trips.
5. Set the TIME DELAY control to the desired time delay and apply nominal frequency to the relay.
6. Step down the applied frequency from nominal to just below the trip level set in Step 4 and measure the time delay.
7. Adjust the TIME DELAY and repeat steps 5 and 6 until the desired time delay is set.

WD810U Controls

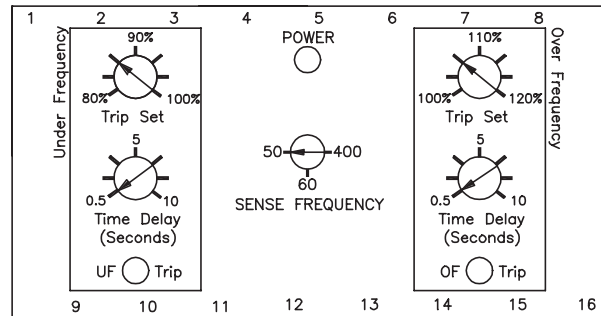

WD810U Connections

